

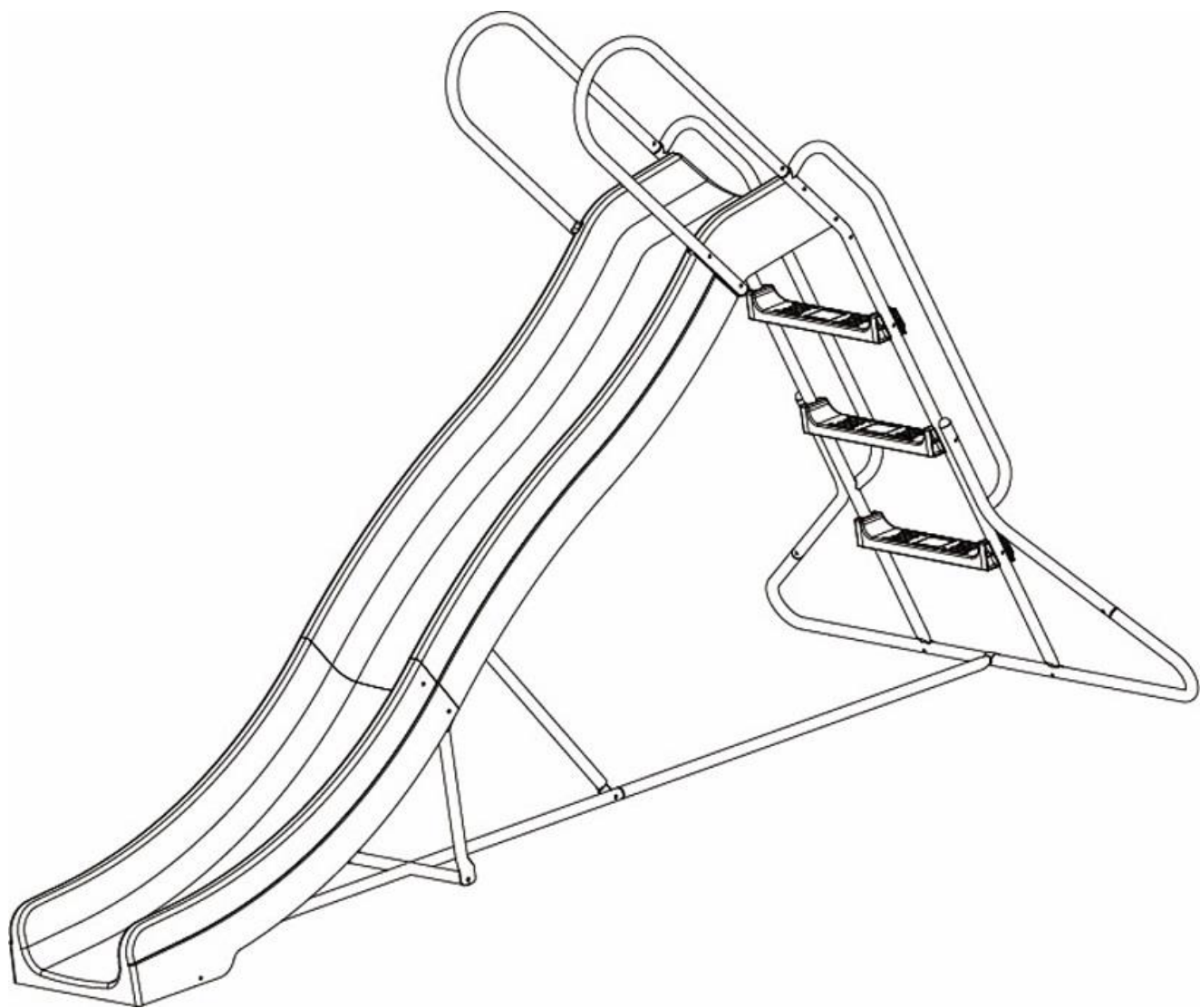









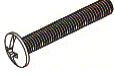







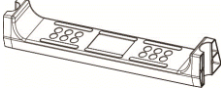
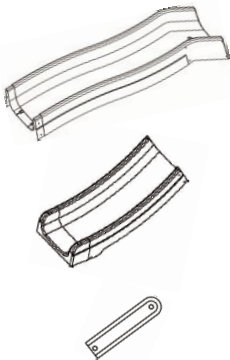
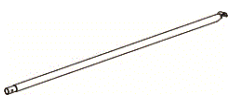
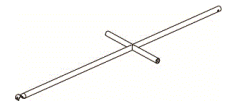

Family XL
1293_68447

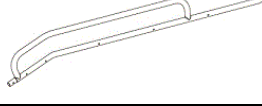

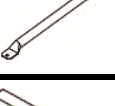
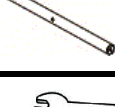
1293_68447

Ref	Description	Qty	Illustration
A	M6 60mm bolt	2	
B	M6 45mm bolt	4	
C	M6 35mm bolt	17	
C1	M8 35mm bolt	2	
D	M6 20mm bolt	2	
E	M6 15mm bolt	6	
F	M6 washer	21	
G	M6 spring washer	27	
G1	M8 spring washer	2	
H	M6 domnut	21	
H1	M8 domnut	2	
I	M6 square domnut	6	
J	Ladder step	3	

Ref	Description	Qty	Illustraion
L	Top wavy slide chute	1	
M	Bottom wavy slide chute	1	
M1	Plastic spacer	2	
N	Tie bar	1	
O	Cross tie bar	1	
P	Ladder stabilizer bar	1	
Q	L/R support bar	2	
R	Main handrail tube	2	
S	Top handrail tube	2	
U	Support bar for Top slide chute	1	
V	L/R support bar for bottom slide chute	2	
W	Support bar for bottom slide chute	1	
X	M6 Spanner	1	
X1	M8 Spanner	1	
Y	Ground anchor	2	

Z	Plastic end-cap	3	
Z1	Plastic end-cap	2	

Tools required :

1. Combination wrench 10



2. Philips head screw driver



3. Use the Component List to ensure all parts are present.

4. Do not attempt to assemble the slide if any parts are missing

EN: SAFETY NOTES

To prevent damage and accidents to persons and/or property, the following instructions and advice must be followed:

1. Read these instructions carefully & strictly follow the instructions before assembling the product or using it for the first time.
2. Do not use any accessories other than those provided and /or specified by the manufacturer.
3. Not suitable for children under 3 years as contains small parts and insufficient strength.
4. This equipment must be assembled and checked by an adult.
5. The instructions contain important information for your safety, correct use and maintenance of this product. Please keep the instructions in a safe place for your future reference.
6. Check all nuts and bolts before every use to ensure they are tight enough.
If not please tighten before use.
7. Check all nuts and bolts for tightness and tighten when required.
8. Check all coverings and bolts for sharp edges and replace when required.
9. Place this equipment on a level surface at least 2 meters from any structure or obstruction such as a fence, garage, house, overhanging branches, laundry line or electrical wires.
10. Other persons must never be allowed to stand within the range of action of the equipment when in use.
11. DO NOT install this equipment on concrete, asphalt or any other hard surface.
12. Do not fully tighten all nuts and bolts until the full unit has been assembled this will ease the assembly process and enable changes to any mistakes made.
13. Always supervise young children at play, until they are physically competent and confident.
14. This item is not designed for adults or maximum weight of 1 child not to exceed 50kgs.
15. DO NOT allow children to stand on the slide chute and over load in one play element.
16. DO NOT allow loose, baggy (or hooded) clothes to be worn, since children can get trapped and may be unable to free themselves.
17. DO NOT allow children to climb on parts on this equipment not intended for this purpose
18. Regularly check the item for wear and damage, removing the item from use when necessary until replacement parts are fitted.
19. Please remove all packaging including shrunk-on film, polybag, carton, pallet, etc. before giving to a child.
20. This product is for home use only and has not been designed for commercial use in play fitness centers, nurseries, etc.
21. Failure to assemble this item as per the instruction may cause injury to the user.
22. Age suitability: 3-10 years.
23. Do not put your hand near moving parts.
24. Please note that changes in temperature may affect the surface of the slide.
Please store away in adverse weather conditions.
25. Warning. Only for domestic use.
26. Please position the equipment so the user is not facing into the sun.
Always have the sun behind the user.
27. To keep the assembly and installation instructions for further reference.

FR: NOTES DE SECURITE

Pour prévenir des dommages et accidents aux utilisateurs et/ou sur la propriété, les instructions et conseils suivants doivent être scrupuleusement suivis :

1. Veuillez lire les instructions entièrement et avec attention avant d'assembler le produit ou de l'utiliser pour la première fois.
2. N'utilisez aucun accessoire autre que ceux fournis/spécifiés par le fabricant.
3. Ne convient pas aux enfants de moins de 3 ans car il contient des petites pièces.
4. Cet équipement doit être assemblé et vérifié par un adulte.
5. Cette notice contient des informations importantes pour votre sécurité, veuillez les respecter afin d'utiliser correctement ce produit. Gardez ces instructions dans un endroit sauf pour une référence future
6. Vérifiez tous les écrous et boulons avant chaque utilisation pour vous assurer qu'ils sont bien serrés. Sinon serrez-les avant utilisation.
7. Vérifiez le serrage de tous les boulons et écrous, et serrez si nécessaire.
8. Vérifiez toutes les recouvrement des boulons afin d'éviter les bouts coupants, remplacez-les si nécessaire
9. Placez cet équipement sur une surface, éloignée de 2 mètres minimum de toute structure, obstacle, ou possible dangers comme des murs, des piscines, tout autre équipement de terrain de jeu, cordes à linge, surfaces dures et/ou chaussées et routes.
10. Des autres personnes ne doivent jamais être autorisées à se tenir dans le champs d'action de l'équipement quand vous l'utilisez
11. N'installez pas cet équipement sur une surface trop dure, comme l'asphalte, le béton ou une autre surface très dure.
12. Ne serrez pas tous les raccords jusqu'à ce que l'assemblage soit complet (pour cet appareil) puis, serrez fortement.
13. Toujours surveiller les enfants quand ils jouent, jusqu'à ce qu'ils soient physiquement compétent et digne de confiance.
14. Cet appareil n'est pas pour une utilisation des adultes ou des enfants excédants 50 kg.
15. NE LAISSEZ PAS les enfants se mettre debout sur aucune partie des équipements du jeu ou surcharger le jeu
16. NE LAISSEZ PAS les enfants porter des vêtements larges, amples ou à capuches car l'enfant peut être piégé et peu ne pas se libérer de lui-meme
17. NE LAISSEZ PAS les enfants monter sur des parties qui ne sont pas faites pour.
18. Vérifiez régulièrement l'objet pour prévenir de l'usure et de différents dommages, retirez les pièces de l'utilisation quand c'est nécessaire, et remplacez-les quand vous le pouvez.
19. Veuillez retirer tout le packaging inclus le ruban adhésif, le papier bulle, le carton, la palette, ... etc, avant de laisser un enfant jouer avec.
20. Ce produit est pour un usage domestique uniquement et n'est pas désigné pour un usage commercial ou l'utiliser en centre de fitness, infirmeries etc ...
21. Echouer en montant l'équipement selon les instructions peut vous causer des blessures.
22. Age convenable pour utilisation : 3-10 ans
23. Ne mettez pas vos mains proche des parties en mouvement.
24. Notez que les changements de température peuvent affecter la surface du toboggan. Veuillez le stocker à l'abri de toute condition météorologique défavorable.
25. Attention. Uniquement pour un usage domestique.
26. Placez l'équipement de sorte à ce que l'utilisateur de l'équipement ne soit pas éblouis par le soleil. Toujours avoir le soleil derrière l'utilisateur.

27. Gardez les instructions pour référence future.

ES : INSTRUCCIONES DE SEGURIDAD

Para beneficiarse de esta garantía de seguridad, respetar las instrucciones de montaje, de seguridad y de mantenimiento, detalladas en este documento

1. Lea atentamente todas las partes de este manual y siga estrictamente las instrucciones antes de usarlas.
2. Se aconseja retirar los aparatos durante el período invernal para evitar las degradaciones provocadas por la intemperie
3. Este producto no es adecuado para niños menores de 3 años. Los pequeños elementos son susceptibles de ser tragados.
4. Respetar escrupulosamente las instrucciones de montaje. El montaje tiene que estar efectuado por un adulto
5. Conservar imprescindiblemente las instrucciones para consultarlas en caso de necesidad
6. Controle que los tronillos y las tuercas sean bien apretados.

Si no, apretarlos antes del uso

7. Compruebe que todas las tuercas y tornillos estén apretados y apriételes cuando sea necesario. sustituir los cubrepernos faltantes, volver a apretar las tuercas y pernos si es necesario,
8. Check all coverings and bolts for sharp edges and replace when required.
9. Instalar el producto en un lugar espacioso, a 2 (dos) metros como mínimo de cualquier objeto, estructuras u obstáculos (paredes, barreras, setos, árboles, cables para colgar ropa o cables eléctricos, etc....) susceptibles de lesionar a sus hijos durante la utilización del juego
10. Otras personas no pueden nunca ponerse de pie en el campo de acción del producto cuando utilizándole

Privilegiar el césped o un terreno blando.

12. Se aconseja montar totalmente el producto antes de apretar completamente todos los tornillos.
 13. Su utilización debe hacerse bajo la vigilancia de un adulto
 14. Está destinado a un niño de un peso máximo de 50 kg .
 15. NO DEJE los bebés ponerse de pie sobre el asiento y sobrecargar el producto.
 16. NO DEJE libre llevar, baggy (or encapuchado) ropas, porque niños pueden ser atrapados
 17. NO DEJE LOS niños saltar del asiento, de las escaleras o ir al alto del producto porque puede provocar lesiones graves
 18. Se aconseja proceder regularmente a algunas verificaciones: hay que evitar la presencia de aristas vivas, sustituir los cubrepernos faltantes, volver a apretar las tuercas y pernos si es necesario, de manera a evitar que el producto constituya un peligro o se pueda volcar
 19. No tirar los embalajes en el entorno natural y no dejarlos al alcance de los niños.
 20. Este producto está destinado únicamente para un uso familiar en el exterior. No puede en ningún caso ser utilizado para las colectividades: escuelas, campings, hoteles, lugares públicos etc.
 21. No montar el producto como es dicho en las instrucciones puede causar lesiones graves.
 22. Productos destinados a niños entre 3 y 10 años
 23. No ponga sus manos cerca de partes que están moviendo
 24. Tenga en cuenta que los cambios de temperatura pueden afectar la superficie del tobogán
- Por favor, almacenar lejos en condiciones meteorológicas adversas.
25. "¡ ATENCIÓN ! Exclusivamente para uso familiar al aire libre."
 26. les recomendamos que no orienten la deslizadera frente al sol
 27. Conservar imprescindiblemente las instrucciones para consultarlas en caso de necesidad

IT: NOTE DI SICUREZZA

Per evitare gli incidenti e di danneggiare il prodotto, bisogna tenere conto delle istruzioni e dei consigli seguenti:

1. Leggere con attenzione tutto il manuale e seguire le istruzioni prima di usare il prodotto.
2. Non utilizzare accessori che non sono stati forniti e/o specificati dal fabbricante.
3. Non è adatto per i bambini che hanno meno di 3 anni.
4. Questo prodotto deve essere montato, smontato e verificato da un adulto.
5. Mantenere il manuale d'istruzione completo per futuro riferimento.
6. Verificare che tutte le viti e tutti i bulloni siano stretti prima di utilizzare il prodotto
7. Verificare che tutte le viti e tutti i bulloni siano stretti e restringere quando è necessario.
8. Prima di utilizzare il prodotto bisogna verificare e rimpiazzare le parti usate, danneggiate o che mancano.
9. Piazzare il prodotto su una superficie piatta ad almeno 2 metri di distanza di qualsiasi struttura o ostacolo, come una barriera, una piscina, un garage, una casa, dei rami d'albero, il filo per stendere la biancheria o i fili elettrici.
10. Le persone che non usano il prodotto non hanno il diritto di essere vicini al prodotto quando è utilizzato.
11. Non piazzare il prodotto sull'asfalto, sul cemento o su una superficie dura.
12. Prima, stringere le viti con la mano finché il prodotto sia montato completamente (per rendere più facile il montaggio) poi stringere forte.
13. Sempre sorvegliare i bambini quando giocano, finché siano fisicamente competenti e fiduciosi.
14. Non ci deve essere più di 1 bambino alla volta sul set multigioco. Non bisogna superare il peso massimo di 50 kg.
15. Non lasciare i bambini stare in piedi su i sedili e non bisogna sovraccaricare il prodotto.
16. Non lasciare i bambini scendere dal prodotto finché non siano fermi.
17. Non lasciare i bambini arrampicarsi sulle parti del prodotto (sedili, i tubi...) perché potrebbero ferirsi gravemente.
18. Verificare regolarmente il prodotto per vedere se è danneggiato o usato, non bisogna utilizzare il prodotto finché le parti danneggiate non siano state rimpiazzate.
19. Bisogna togliere tutti gli elementi d'imballo come la plastica, il cartone, ect... prima di utilizzare il prodotto.
20. Questo prodotto è stato concepito solo per l'uso domestico. Non è stato concepito per un uso commerciale come nei centri sportivi, asili nido, etc...
21. Se il prodotto non è montato come è indicato nelle istruzioni, può essere pericoloso per l'utente e può ferirlo.
22. Età: tra 3 e 10 anni.
23. Non mettere le mani vicino alle parti che si muovono.
24. Cambiamenti di temperatura possono incidere sulla superficie dello scivolo. Bisogna mettere il prodotto al riparo quando non si utilizza.
25. "Attenzione: Per un uso esclusivamente domestico e esterno."
26. Posizionare il prodotto in modo che l'utente abbia sempre il sole dietro di lui.
27. Mantenere queste istruzioni per futuro riferimento.

E=M6x15mm x 6pcs
D=M6x20mm x 2pcs
B=M6x45mm x 4pcs



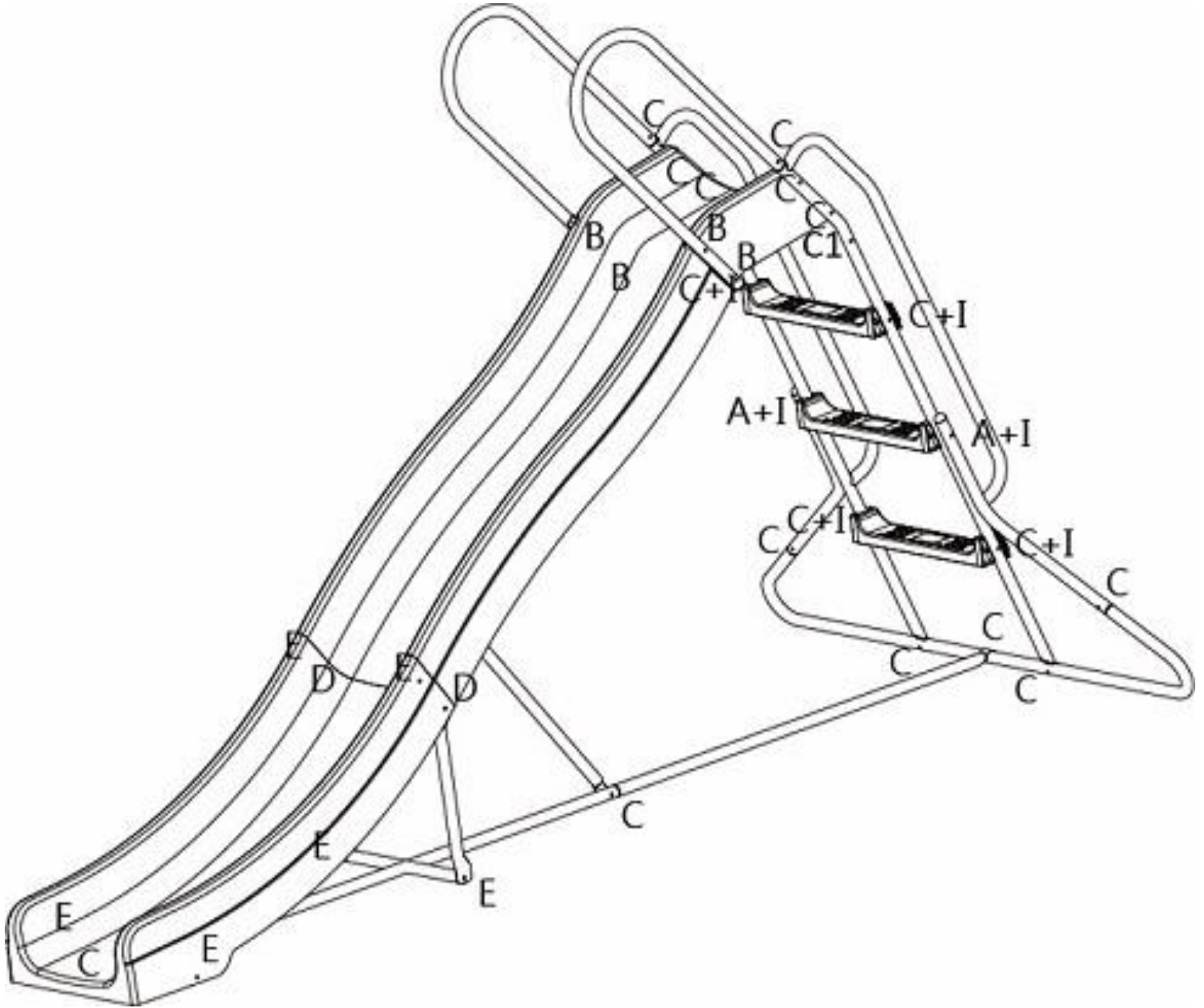

A=M6x60mm x2pcs, I= square dometut x 2pcs
C=M6x35mm x 4pcs, I=square dometut x 4pcs
C=M6x35mm x 13pcs
C1=M8x35mm x 2pcs

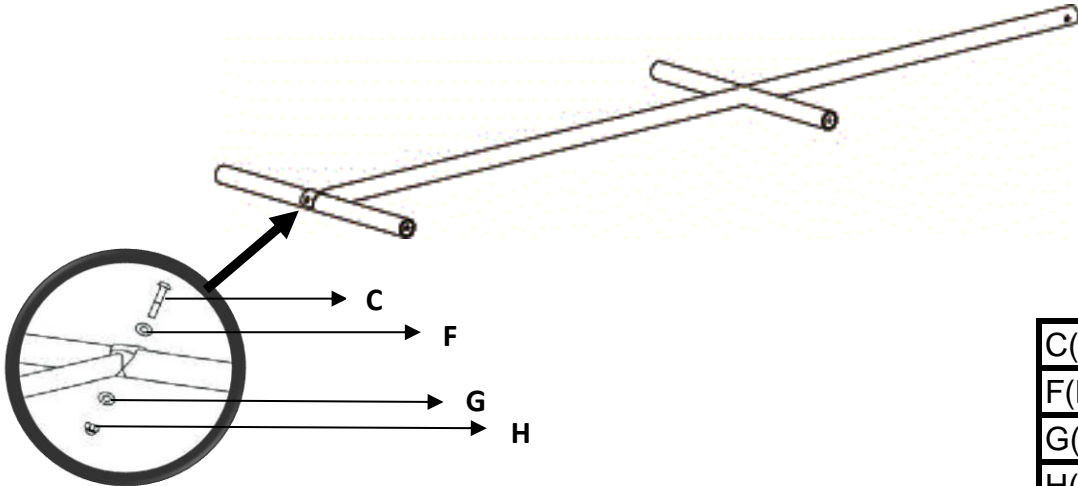

Wavy Slide Assembly/Assemblage du toboggan/ Montaje del tobogán/Assemblare lo scivolo a onda

1



C(M6x35)	1 x	
F(M6)	1 x	
G(M6)	1 x	
H(M6)	1 x	

2

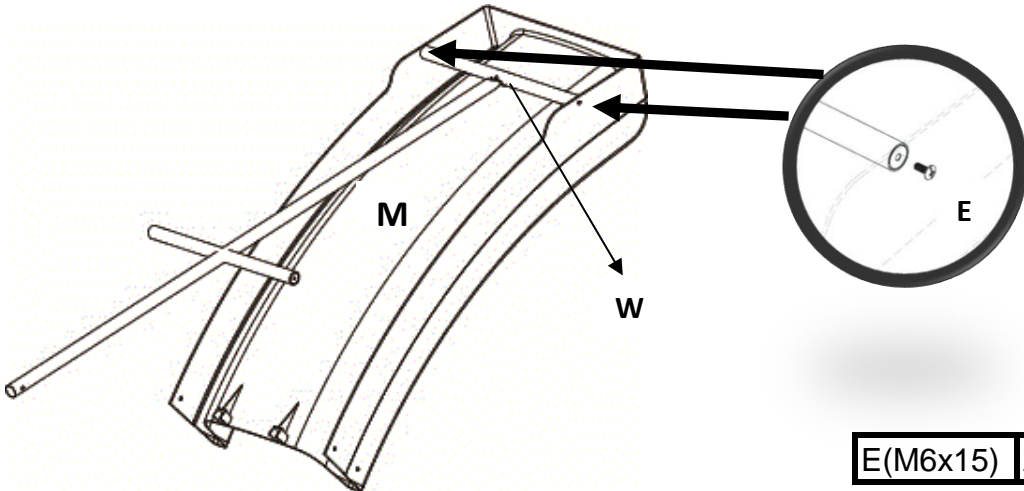

E(M6x15)	2 x	
----------	-----	---

3

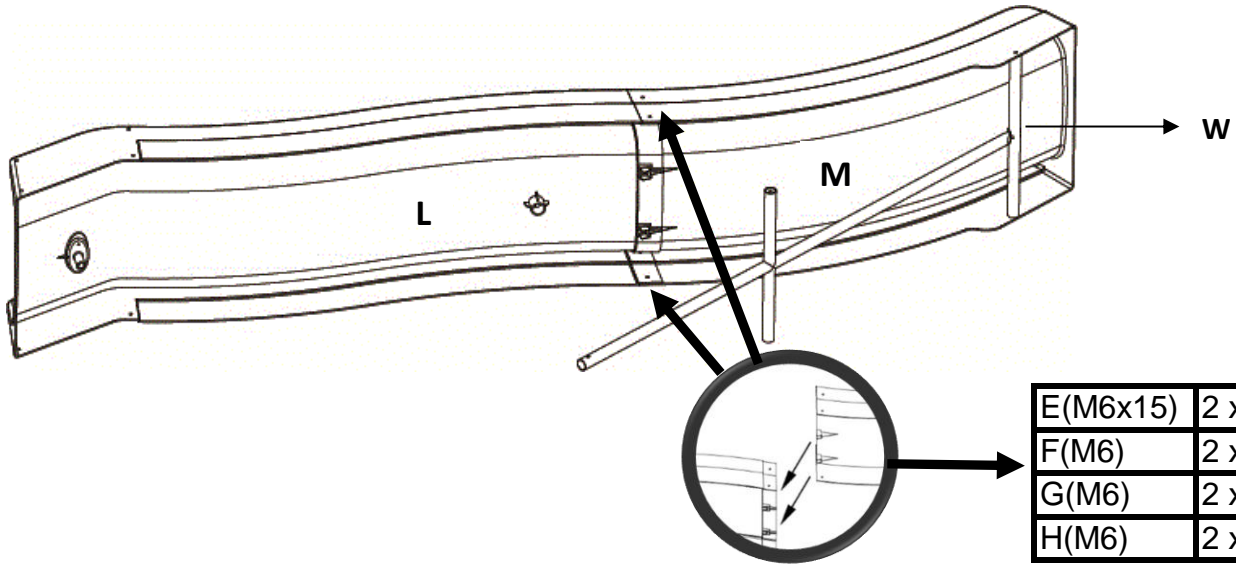

4

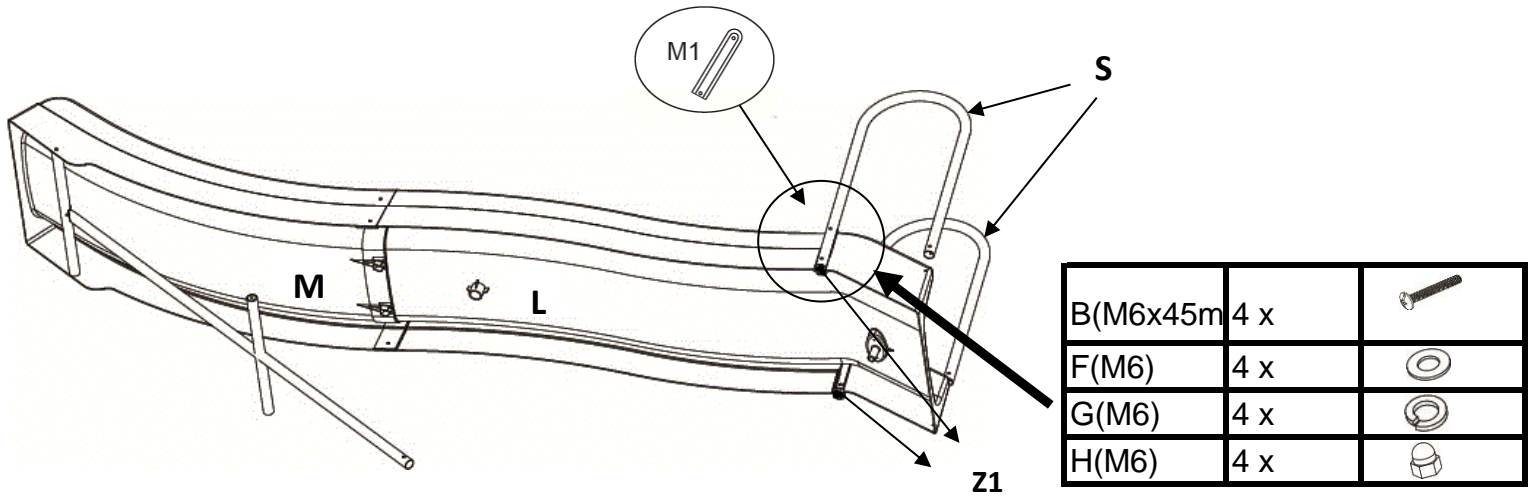

5

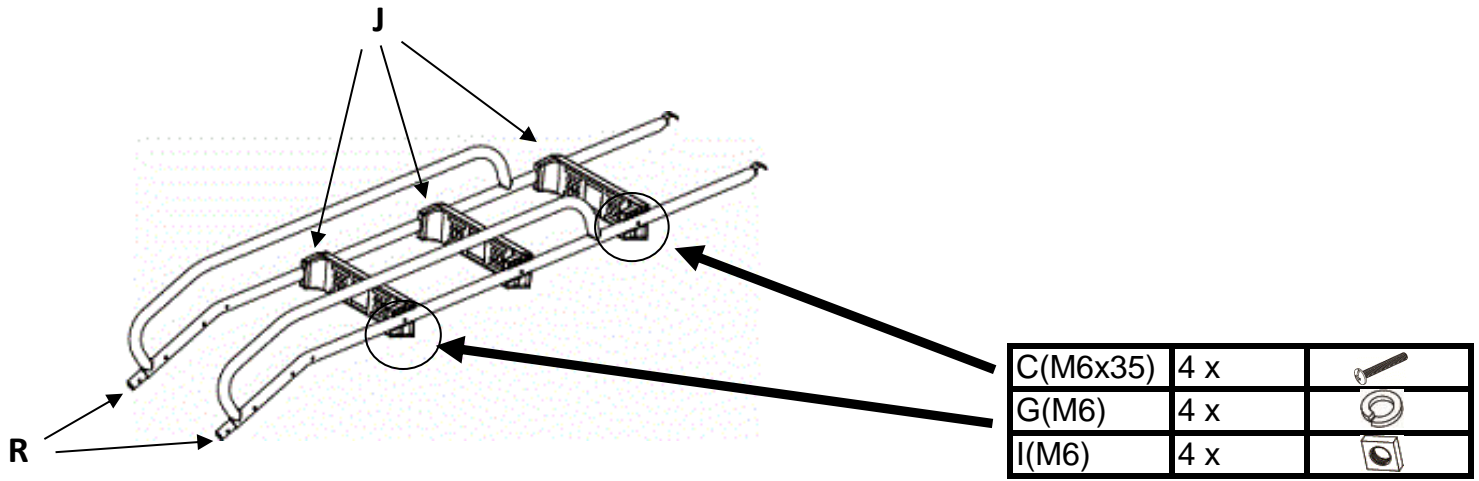



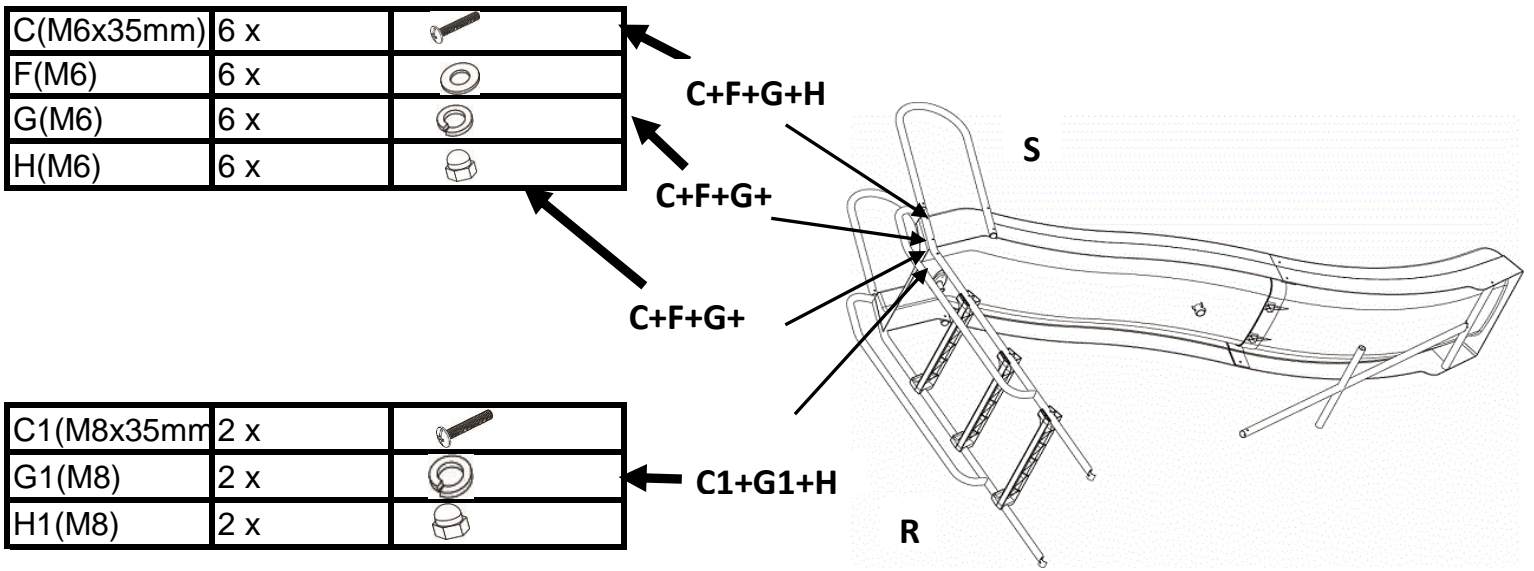

6

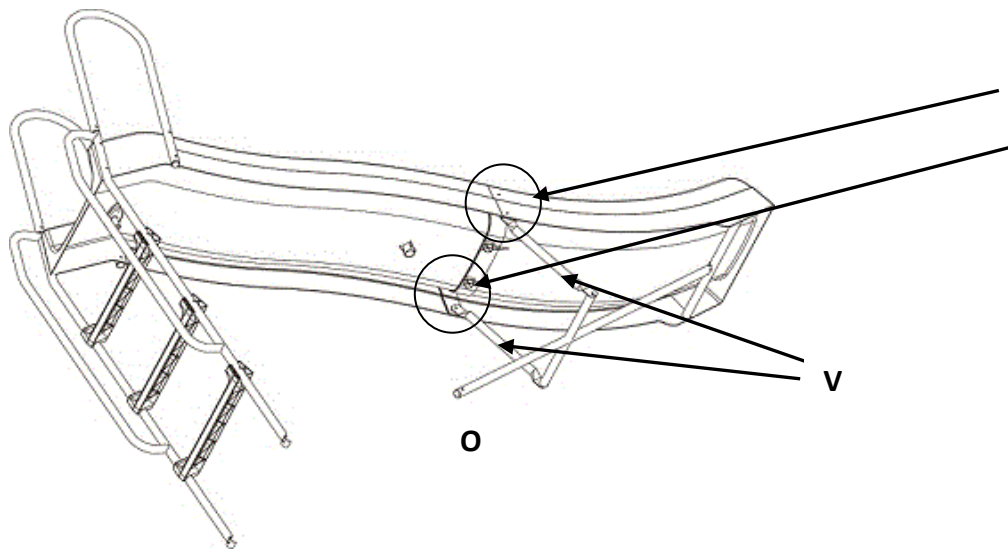





7

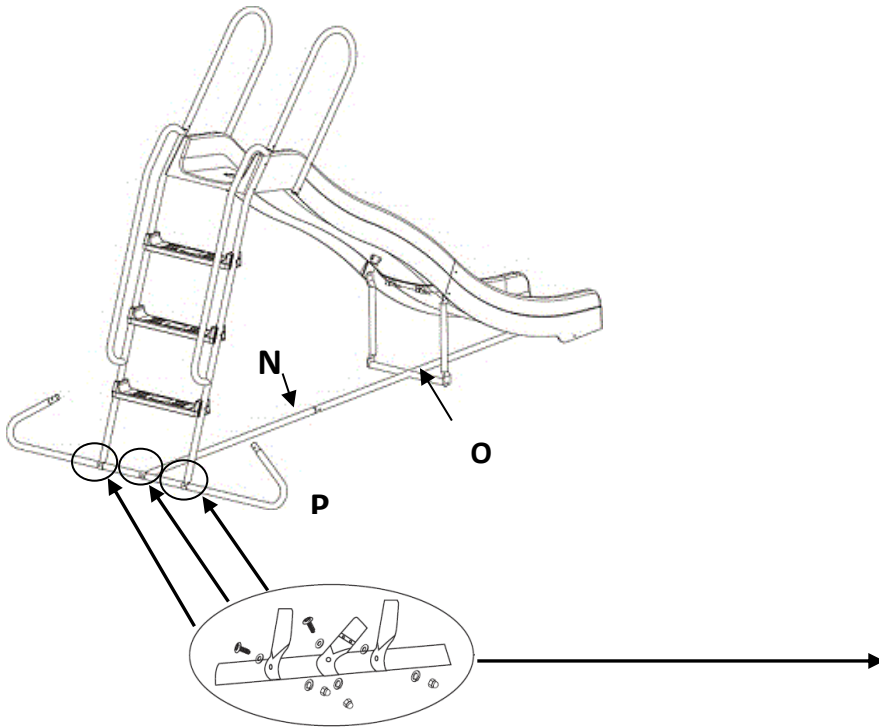

D(M6x20)	2 x	
E(M6x15)	2 x	
F(M6)	2 x	
G(M6)	2 x	
H(M6)	2 x	





8

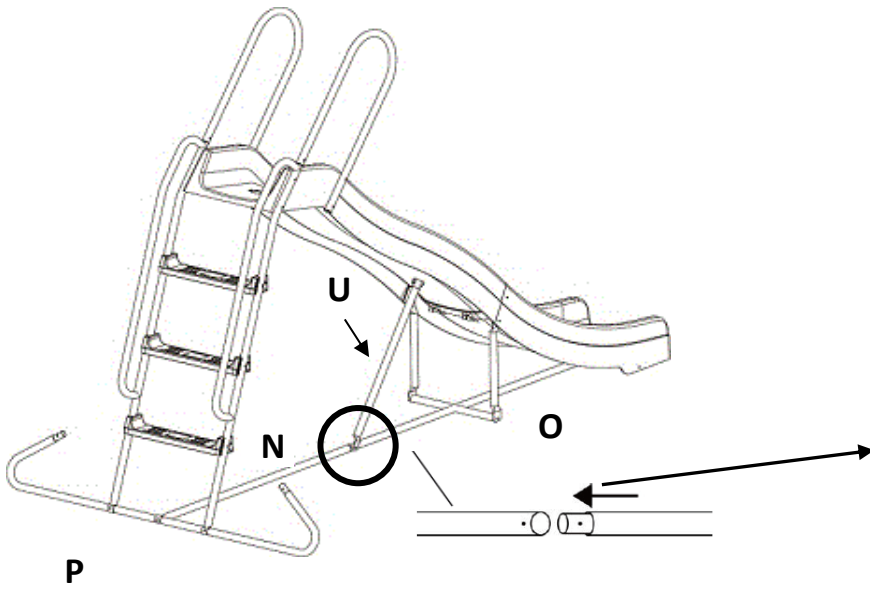

C(M6x35)	3 x	
F(M6)	3 x	
G(M6)	3 x	
H(M6)	3 x	





9

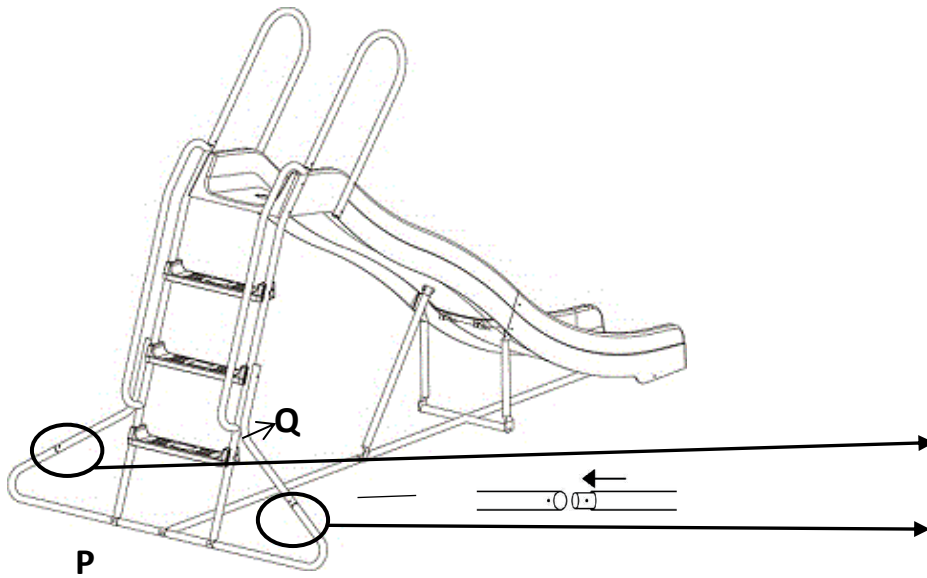

C(M6x35)	1 x	
F(M6)	1 x	
G(M6)	1 x	
H(M6)	1 x	
Z	1 x	





10

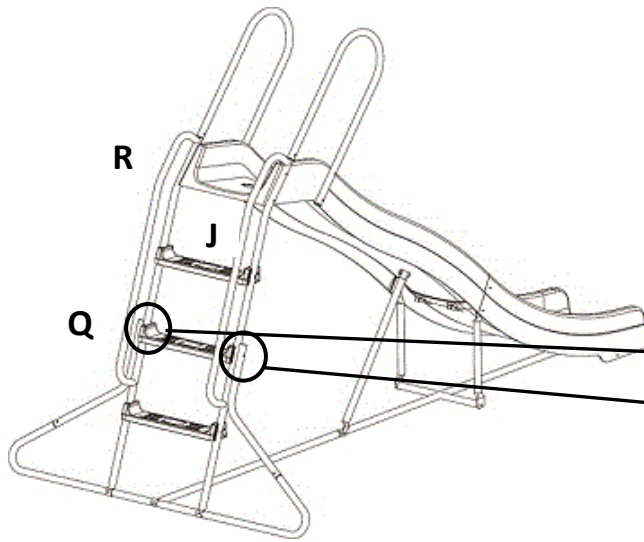

C(M6x35)	2 x	
F(M6)	2 x	
G(M6)	2 x	
H(M6)	2 x	

11



A(M6x60)	2 x	
G(M6)	2 x	
I(M6)	2 x	
Z	2 x	

12

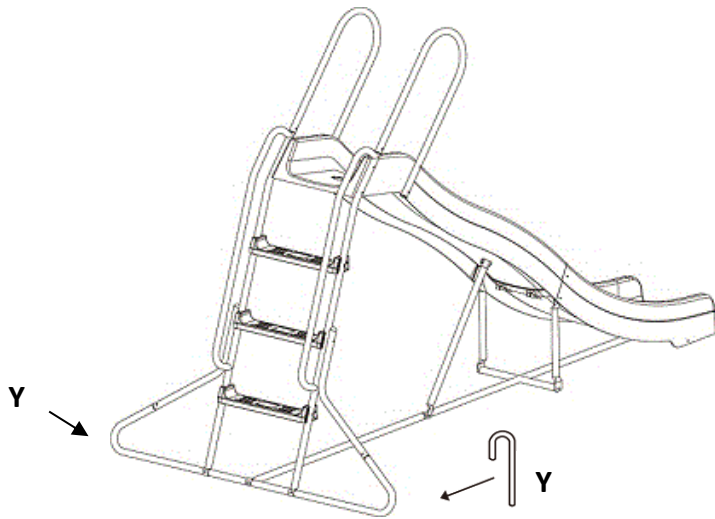

Y	2 x	
---	-----	---

EN: Care and Maintenance

1. This equipment must be assembled and checked by an adult.
2. Regularly check all nuts and bolts for tightness before use and replace any worn, defective or missing parts. DO NOT try to repair broken parts.
3. Regularly check wavy slide, steel tube, step, ground anchor and other parts are tightened completely and replace worn & damaged parts when necessary.
4. Remove worn and damaged parts from use when necessary until replacement parts are fitted.
5. At the beginning of each season, please oil all metallic moving parts to maintain and regularly oil when necessary during the usage season.
6. Wavy Slide placement:
 - (a) Place this equipment on a level surface at least 2 meters from any structure or obstruction. Such as a fence, garage, house, overhanging branches, laundry line or electrical wires.
 - (b) DO not install this equipment on concrete, asphalt or any other hard surface.
 - (c) Place this equipment in a well-lit area.
 - (d) Do not use indoors.
7. Weather condition:
 - (a) Slide should be kept dry--do not use when these parts are wet.
 - (b) Do not use in strong or gusty wind conditions.
 - (c) Please position the equipment so the user is not facing into the sun.
Always have the sun behind the user.
8. This item is not designed for adults or maximum weight of 1 child not to exceed 50 kgs.
9. Please keep these instruction in a safe place for future reference.
10. To keep clean of this equipment.

FR: Soin et entretien

1. Cet équipement doit être assemblé et vérifié par des adultes exclusivement.
2. Vérifiez régulièrement les écrous et boulons avant utilisation et remplacez toute pièce usée, défectueuse ou manquante. N'essayez pas de réparer les parties cassées.
3. Vérifiez régulièrement la balançoire, les tubes métalliques, les cordes, l'ancrage au sol, et les autres parties qui sont vissées ou complètement fixées, et remplacez les pièces usées & endommagées si nécessaire. Si ces vérifications ne sont pas faites sérieusement, cet équipement peut se renverser ou autre et donc devenir un danger.
4. Retirez les parties usées et endommagées quand leur remplacement est nécessaire.
5. Au début de chaque saison, veuillez bien huiler les parties métalliques mobiles pour les maintenir et régulièrement les huiler quand cela devient nécessaire durant le cours de la saison.
6. Placement du set balançoire, et face à face.
 - (a) Placez cet équipement sur une surface éloignée de 2 m de toute structure ou obstruction. Tel qu'une clôture, un garage, une maison, des branches d'arbres, des cordes à linge ou des câbles électriques.
 - (b) N'INSTALLEZ PAS cet équipement sur des surfaces trop dures, comme l'asphalte, le béton ou autre.
 - (c) Placez cet équipement dans un endroit éclairé.
 - (d) Ne l'utilisez pas en intérieur
7. Conditions climatiques :
 - (a) Le toboggan doit être sec, et ne pas l'utiliser si il est mouillé
 - (b) Ne pas utiliser si le vent est fort ou s'il y a des rafales
 - (c) Positionnez l'équipement pour ne pas avoir le soleil dans les yeux.
8. Cet item n'est pas désigné pour les adultes, et l'enfant ne doit excéder 50 kg.
9. Veuillez garder ces instructions dans un endroit sauf pour une future référence.
10. Gardez propre cet équipement.

ES: Mantenimiento

1. El montaje tiene que estar efectuado por un adulto
2. Verificar regularmente el apretado de todos los tornillos y de las tuercas y antes del uso, y cambiarles si necesite, si hay partes defectuosas o que faltan. NO INTENTE reparar piezas rotas.
3. Verifique regularmente el asiento, las cuerdas, los tubos de acero, las fijaciones en el suelo y otras partes, que están apretados completamente y reemplace las piezas usadas y dañadas cuando es necesario.
4. Retirarse las partes usadas y con daños del uso cuando es necesario hasta su reemplazo

5. No dude en engrasar las partes de fuerte roce con lubricantes de gel adaptados.

6. Colocación de productos :
 - (a) Instalar el producto en un lugar espacioso, a 2 (dos) metros como mínimo de cualquier objeto, estructuras u obstáculos (paredes, barreras, setos, árboles, cables para colgar ropa o cables eléctricos, etc.) susceptibles de lesionar a sus hijos durante la utilización del producto.
 - (b) La implantación de este producto no debe hacerse sobre un terreno duro (hormigón, asfalto, etc.). Privilegiar el césped o un terreno blando.
 - (c) Poner el producto en un lugar con luz
 - (d) Exclusivamente para uso familiar al aire libre
7. Condiciones climáticas
 - (a) El producto sólo debe ser utilizado por los niños una vez que el sellado esté perfectamente seco
 - (b) Los movimientos de aire debe ser tranquilo y dulce
 - (c) les recomendamos que no orienten la deslizadora frente al sol
8. este producto no es adecuado para adultos.
Está destinado a un niño de un peso máximo de 50 kg.
9. Conservar imprescindiblemente las instrucciones para consultarlas en caso de necesidad
10. Mantener limpio este equipo.

1. Questo prodotto deve essere montato e verificato da un adulto.
2. Verificare frequentemente che le viti e i bulloni siano stretti prima di utilizzare il prodotto e bisogna rimpiazzare le parti danneggiate, usate e che mancano. Non provare di riparare le parti rotte.
3. Verificare frequentemente che lo scivolo, le fissazioni, i tubi siano stretti e bisogna rimpiazzare le parti danneggiate.
4. Bisogna rimpiazzare le parti danneggiate conformemente alle istruzioni del fabbricante.
durante il periodo d'uso.
6. Posizionamento dell'altalena per bambino
 - (a) Piazzare il prodotto su una superficie piatta ad almeno 2 metri di distanza di qualsiasi struttura o ostacolo, come una barriera (recinto), un garage, una casa, dei rami d'albero, il filo per stendere la biancheria o i fili elettrici.
 - (b) Non piazzare il prodotto su una superficie di cemento, sull'asfalto o altre superficie dure.
 - (c) Mettere il prodotto in un luogo luminoso.
 - (d) Non utilizzare il prodotto all'interno.
7. Condizioni meteorologiche
 - (a) Proteggere lo scivolo dall'acqua e proibire l'utilizzazione quando è bagnato.
 - (b) Non utilizzare se c'è vento forte.
 - (c) Non utilizzare se ci sono rischi di diventare ciechi a causa dei raggi del sole, o cambiare la posizione dello scivolo per evitare i raggi.
8. Questo prodotto non è stato concepito per essere utilizzato dagli adulti.
Il peso massimo che può essere sopportato è di 50kg.
9. Mantenere questo manuale d'istruzione per futuro riferimento.
10. Bisogna pulire l'altalena frequentemente.

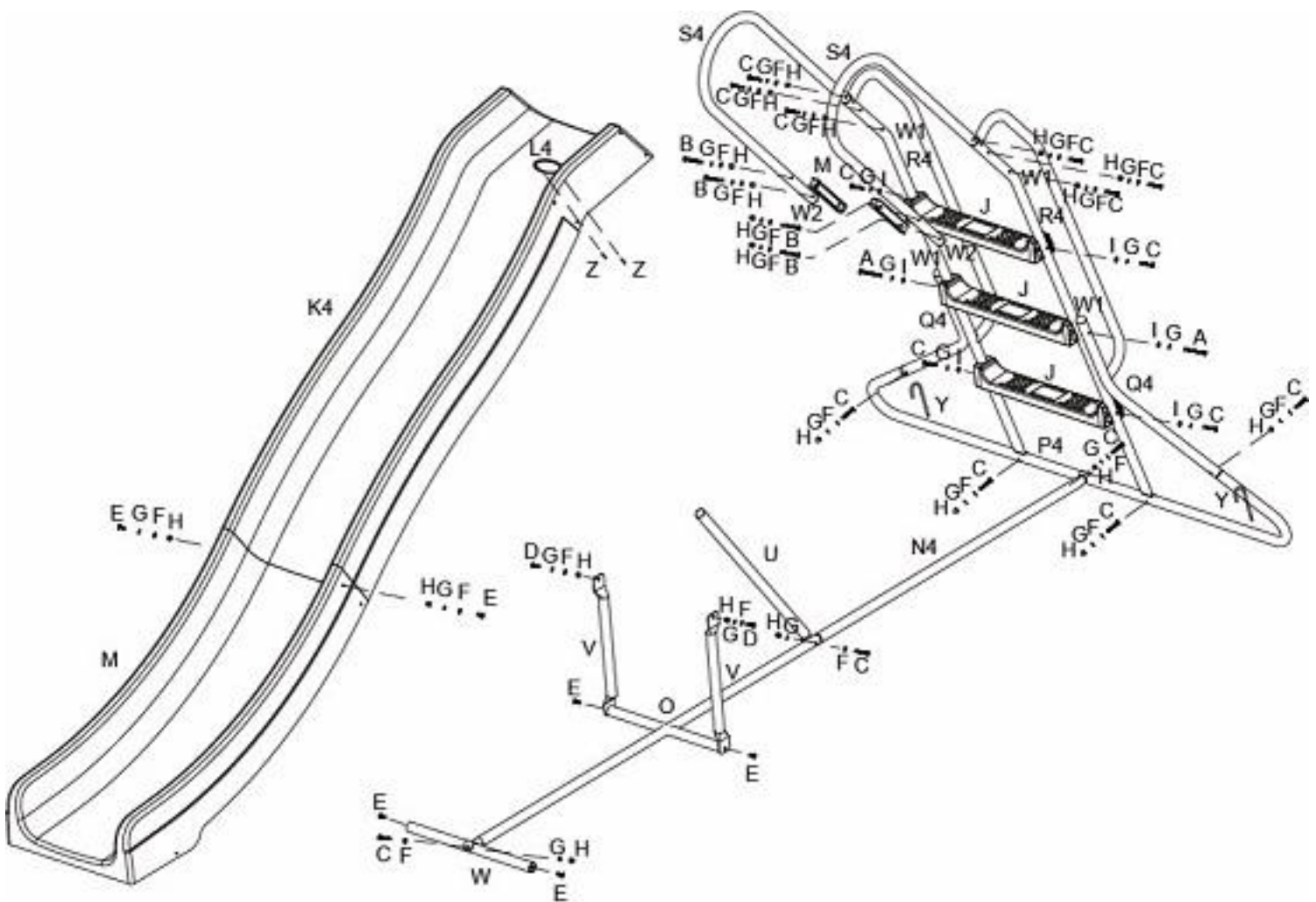

commercializing the product / Responsable de la comercializacion del producto / Responsabile della commercializzazione del prodotto:

GECODIS SA
32, rue de paradis
75010, Paris, France

Service commercial/ Commercial service/ Servicio comercial / Servizio commerciale :

Habitatetjardin.com
32, rue de paradis
75010, Paris, France
Assistance : +33 (0) 1 47 70 33 64

Service après-vente/ After sale services/ Servicio post-venta / Servizio dopo vendita:

GECODIS SA
32, rue de paradis
75010, Paris, France
<http://sav.habitatetjardin.com>

**Attention ! Ne convient pas aux enfants de moins 3 ans.
Petites parties – Danger d'étouffement.
Présence de cordes – Danger de strangulation.**



**Warning! Not suitable for kids under 3 years hold.
Tiny pieces – Danger of suffocation.
Presence of rope – Danger of strangulation.**



**¡Advertencia! No es adecuado para niños menores de 3 años.
Piezas pequeñas – Peligro de asfixia.
Contiene cuerdas – Peligro de estrangulación.**



**Attenzione! Non è adatto per i bambini che hanno meno di 3 anni.
Piccole parti – Pericolo di soffocamento.
Presenza di corde – Pericolo di strangolamento.**

